

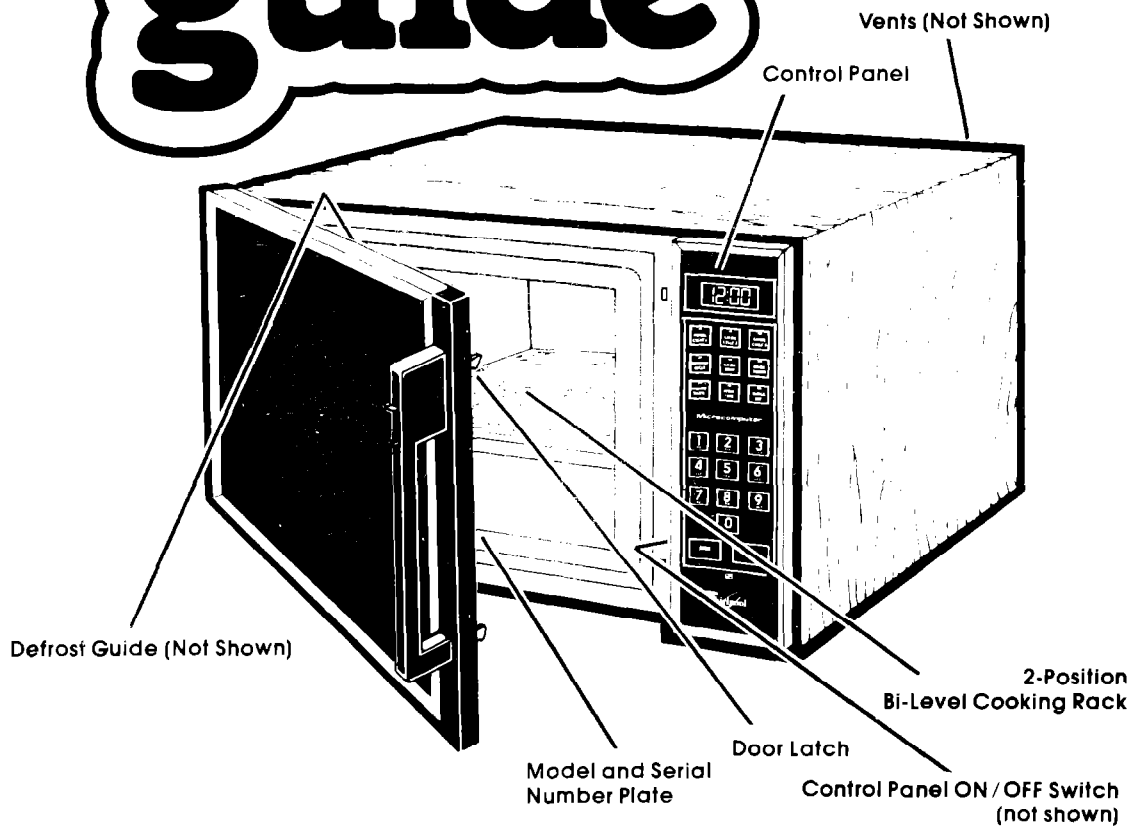

Microwave Oven Model MW8700XL

use & care guide



Copy You: Model and Serial Numbers Here

If you need service or call with a question, have this information ready:

1. **Complete** Model and Serial Numbers (from the plate just behind the microwave oven door on the oven frame)
2. Purchase date from sales slip or date installed

Copy this information in these spaces. Keep this book, your warrant, and sales slip together in a handy place.

Model Number

Serial Number

Purchase / Installation Date

Service Company and Phone Number

Contents

	Page		Page
Responsibilities	2	Cooking with The Temperature	
Installation	2	Probe	14
Proper, Safe Use	3	Cooking to a Serving Time	16
Precautions to Avoid Possible		Serve Time and the Temperature	
Exposure to Excessive		Probe	17
Microwave Energy	3	Changing or Cancelling	
Using Your Microwave Oven	4	Instructions	17
Setting The Clock	5	Other Operating Instructions	17
Using the Minute Timer	5	Cleaning the Microwave Oven	17
Cooking in One Cycle	6	Bi-Level Cooking Rack	18
High Cook Power	6	Replacing the Light Bulb	18
Lower Cook Powers	7	Important Information	19
Defrosting	8	How Microwave Ovens Work	21
Faster or Slower Defrosting	9	Building In Your Microwave Oven	21
Cooking in More Than One		If You Need Service or Assistance	22
Cycle	9	1. Before Calling for Assistance	22
Cooking Automatically after		2. If You Need Assistance	22
Defrosting	11	3. If You Need Service	23
		4. If You Have a Problem	23

Your responsibilities...

Fill out and return the "Microwave Registration Card" attached to the oven door.

Installation

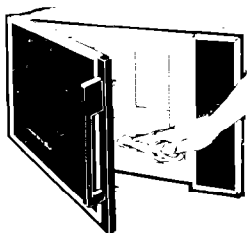

1. Empty the microwave oven and clean inside it with a soft, damp cloth.



2. Put the oven on a cart, counter, table or shelf that is strong enough to hold the oven. **(The control side of the unit is the heavy side. Handling can be tricky.)**

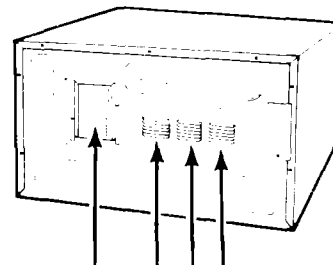

3. Do not block vents on back of the oven. Blocking vents can cause poor cooking results.

4. For your safety, **this oven must be grounded.** DO NOT REMOVE THE THIRD PRONG FROM THE PLUG. You must have a qualified electrician put in the right outlet if yours does not have the 3-prong plug-in, or if the outlet is not grounded according to National Electrical Codes and local codes or ordinances. The outlet must supply 120 volts, 60 Hz., A.C. When the oven is on, it will use about 1375 watts. It should not share a circuit with another appliance.

5. Put about one cup (250 mL) of cold water in a glass container in the oven. Close the door. Make sure it locks. Follow the directions on page 4 to set the oven to COOK for 1 1/2

minutes. When the time is up, the water should be heated.

6. Fill out and return the "Microwave Registration Card" attached to the oven door. If the card is missing, please send the model and serial number of your microwave oven, with your name and address to...

Whirlpool Corporation
Microwave Registration Department
Administrative Center
2000 U.S. 33 North
Benton Harbor, Michigan 49022

This information will help us reach you if there is ever a need to pass along information about your microwave oven.

Proper, safe use

Your microwave must be...

- Installed according to the installation instructions
- Protected from the weather.
- Used only for jobs expected of home microwave ovens.
- Used only by people who can operate it properly.
- Kept clean and in good repair.

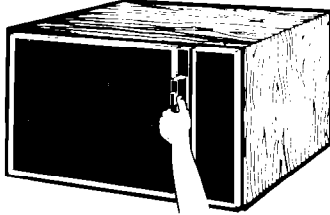

NEVER start the oven when it's empty. The oven can be damaged



DO NOT cook or reheat whole eggs in the microwave oven. Steam build-up can cause an egg to burst. Damage to the oven or injury to the user may result.



DO NOT use the oven until you have read and understand **ALL** the information on safe use.

PRECAUTIONS TO AVOID POSSIBLE EXPOSURE TO EXCESSIVE MICROWAVE ENERGY...

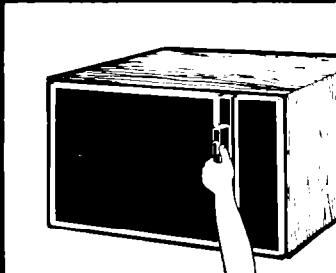

DO NOT attempt to operate this oven with the door open since open-door operation can result in harmful exposure to microwave energy. It is important not to defeat or tamper with the safety interlocks.

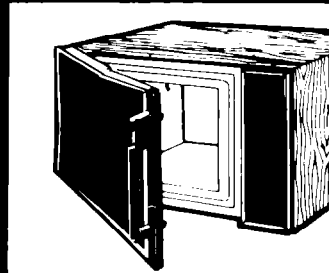

DO NOT operate the oven if it is damaged. It is particularly important that the oven door close properly and that there is no damage to the

- (1) Door (bent),
- (2) Hinges and latches (broken or loosened),
- (3) Door seals and sealing surfaces.

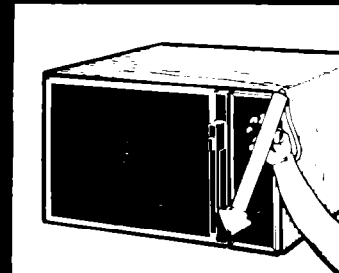

The microwave oven should be checked for microwave leakage by qualified service personnel after a repair is made.

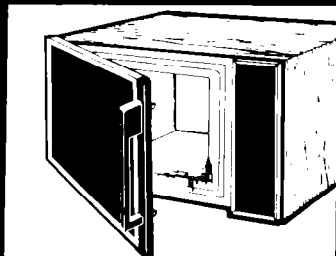

DO NOT place any object between the oven front face and the door or allow soil or cleaner residue to accumulate on sealing surfaces.

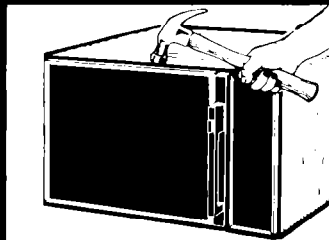

The oven should not be adjusted or repaired by anyone except properly qualified service personnel.

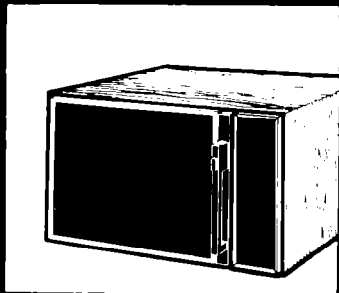

DO NOT operate the microwave oven if the door glass is broken.

DO NOT operate the microwave oven with the outer cabinet removed.

Using your microwave oven

MICROWAVE OVEN CONTROLS

There are three parts in the control section:

- The Digital Display / Clock,
- Command Pads and Signal Lights,
- Number Pads.

What each of these does will be covered on the following pages. Read them carefully.

When you first plug in the oven, the Display will show 88:88. If, after you set the Clock

(page 5), the Display again shows all 8's, it means your electricity was off for a while. Reset the Clock.

One note: The Command and Number Pads are not buttons. You don't have to push them...just touch them.

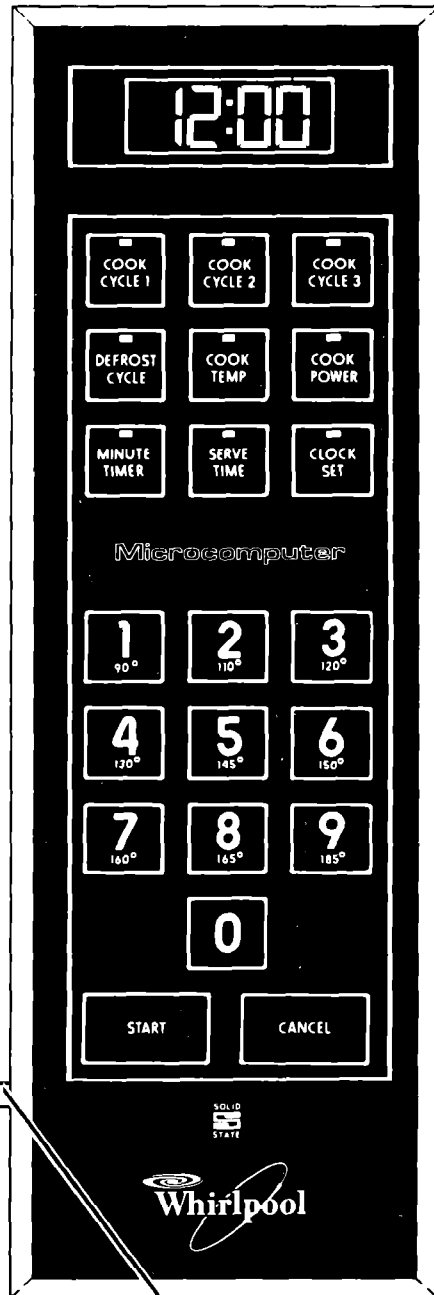

Control Panel ON / OFF Switch

DIGITAL DISPLAY / CLOCK



When you are not using the microwave oven, this is an accurate digital clock.

When you are using the microwave oven, this acts as a display. It counts down time settings and it shows you what number pads you touched.

COMMAND PADS AND SIGNAL LIGHTS

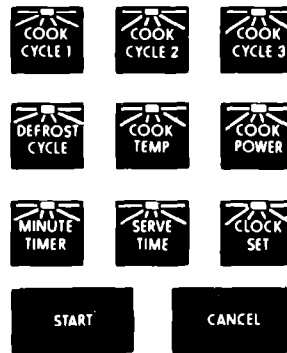

Touch Command Pads to tell the microwave oven what to do and in what order.

A few examples:

- COOK CYCLE 1 (or 2, or 3) tells the oven you are going to cook.
- COOK POWER tells the oven you are going to cook at less than full power.

- START tells the oven to start.

Each Command Pad has its own Signal Light (except START and CANCEL). The Signal Light comes on when you touch the Command Pad.

While the oven is running, a Signal Light (or lights) will be on to show what the oven is doing.

NUMBER PADS

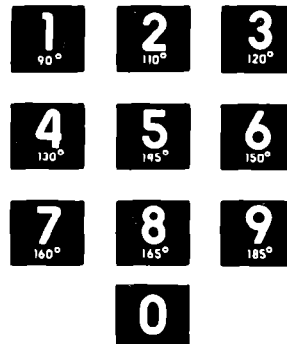

Once you've touched a Command Pad to tell the oven what you want it to do, you'll touch Number Pads to tell it...

- a time,
- a Cook Power,
- a food temperature.

SETTING THE CLOCK

When the oven is first plugged in, the Clock / Display shows **88:88**. If the electric power ever goes off, the Clock / Display will also show all 8's when the power comes back on.

You can cook or use the Minute Timer without setting the clock, but the display will be blank after cooking. **The oven door must be closed before setting the clock.**

DO THIS...



1. Touch **CLOCK SET**.

THIS HAPPENS...



The Signal Light on the **CLOCK SET** pad will come on. Start touching number pads for the desired time within 5 seconds.



2. Touch Number Pads for the correct time of day.



The Display will show what numbers you touched **in the order you touched them**. This example shows 3:25.



3. Touch **START**.



The Clock is set when the **CLOCK SET** Signal Light goes off.

USING THE MINUTE TIMER

The Minute Timer does not start or stop cooking; it works like a kitchen timer. Set in minutes or seconds and you will hear a beep when the set time is up. **The oven door must be closed before setting the Minute Timer.**

DO THIS...



1. Touch **MINUTE TIMER**.

THIS HAPPENS...



The **MINUTE TIMER** Signal Light will come on and the Display will show a "0." Within 5 seconds start touching number pads for the desired time.



2. Touch Number Pads for minutes and seconds.



The Display will show what numbers you touched **in the order you touched them**. This example shows 1 minute, 45 seconds.



3. Touch **START**.



The **MINUTE TIMER** Signal Light will stay on to show that the Minute Timer is running.

The Display counts down the seconds to show how much time is left on the Minute Timer.

count
down

BEEP

When the set time is up, you will hear a beep and the Display will show the time of day.

1. The Minute Timer can be used when the oven is cooking.
2. Opening the microwave oven door does not stop the Minute Timer.
3. If you open oven door and reset the Minute Timer touch START twice to start the Minute Timer and to restart the oven.

To change or cancel the Minute Timer:

1. Touch MINUTE TIMER.
2. Touch number 0 to cancel,
or
2. Touch desired new number pads to change.

Then:

3. Touch START.

THE CONTROL PANEL ON/OFF SWITCH

Just inside the microwave oven door, on the control panel frame, is a switch. The switch is designed to keep "busy little fingers" from using the oven.

When the switch is OFF, the Clock and Minute Timer will work, but the DEFROST and COOK CYCLES cannot be used. The switch must be ON to cook in the microwave oven.

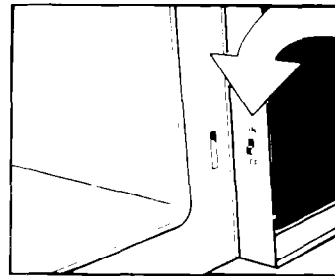

COOKING IN ONE CYCLE

Follow these steps to cook at one power level:

HIGH COOK POWER

DO THIS...

1. Put food in the oven and close the door.



2. Touch COOK CYCLE 1.

THIS HAPPENS...



The COOK CYCLE 1 Signal Light will come on and the Display will show 4 0's.



3. Touch Number Pads for the cooking time you want.



The Display will show the numbers you touched **in the order you touched them**. This example shows 4 minutes, 30 seconds.



4. Touch START.

The oven will automatically cook at high Cook Power.



The COOK CYCLE 1 Signal Light will stay on to show that the oven is cooking in the first cycle.

count
down

BEEP
BEEP
BEEP
BEEP

The Display counts down the time to show how much cooking time is left in the first cycle.

When the cooking time ends you will hear 4 beeps. (You can stop the beeping by opening the oven door or touching CANCEL.) When the beeping stops, the Display will show the time of day.

LOWER COOK POWERS

For best results, some recipes call for lower Cook Powers. Lowering the Cook Power slows the cooking. The lower the Cook Power, the slower the cooking. Each Number Pad on your microwave oven stands for a different percentage of Cook Power. Many recipes in your MICRO MENUS Cookbook tell you, by number, which Cook Power to use. Recipes in other books and magazines may tell you by name (HI, MED, LO, etc.) or by percentage (10%, 50%, 80%, etc.).

The following chart gives you the percentage of Cook Power each Number Pad stands for, and the Cook Power name usually used.

automatic	100% of full power	HIGH		Tmk
9	90% of full power			
8	80% of full power			
7	70% of full power	MED-HI		
6	60% of full power			
5	50% of full power	MED		
4	40% of full power			
3	30% of full power	MED-LO		
2	20% of full power			
1	10% of full power	LOW		

DO THIS...

1. Put food in the oven and close the door.



2. Touch COOK CYCLE 1.



The COOK CYCLE 1 Signal Light will come on and the Display will show 4 0's.



3. Touch Number Pads for the cooking time you want.



The Display will show the numbers you touched **in the order you touched them**. This example shows 7 minutes, 30 seconds.



4. Touch COOK POWER.



The COOK POWER Signal Light will come on and the Display will show 2 0's.



CONTINUED NEXT PAGE



5. Touch a Number Pad for the Cook Power you want.



The Display will show what you touched. This example shows 60% of full power.



6. Touch START.



The COOK CYCLE 1 and COOK POWER Signal Lights will stay on to show that the oven is cooking in the first cycle at a Cook Power other than high.



The Display counts down the time to show how much cooking time is left in the first cycle.



For 2 of every 10 seconds, the Display will show the Cook Power you selected.



When the cooking time ends, you will hear 4 beeps. (You can stop the beeping by opening the door or by touching CANCEL.) When the beeping stops, the Display will show the time of day.

DEFROSTING

Use DEFROST CYCLE to thaw frozen food before cooking. For suggested defrost times, check the guide on the inside of the oven door or in your MICRO MENUS® Cookbook.

Trmk

DO THIS...

THIS HAPPENS...

1. Put frozen food in the oven and close the door.



2. Touch DEFROST CYCLE.



The DEFROST CYCLE Signal Light will come on and the Display will show 4 0's.



3. Touch Number Pads for the defrosting time you want.



The Display will show the numbers you touched **in the order you touched them**. This example shows 2 minutes, 30 seconds.



4. Touch START.



The DEFROST CYCLE Signal Lights will stay on to show that the oven is in the Defrost Cycle.



The Display counts down the time to show how much defrosting time is left.



When the defrost time ends, you will hear 4 beeps. (You can stop the beeping by opening the oven door or touching CANCEL.) When the beeping stops, the Display will show the time of day

FASTER OR SLOWER DEFROSTING

When you touch DEFROST CYCLE, the microwave oven automatically uses 30% of full Cook Power. For slower or faster defrosting, see **Lower Cook Powers** on page 7

- Use 20% of full power for slower defrosting.
- Use 40% of full power for faster defrosting. **Defrosting at Cook Powers higher than 30% can cause some cooking on the outside of the food.**

STANDING TIME:

For best results allow the food to stand for a while after defrosting. This will equalize the temperature of the food and provide more even defrosting.

COOKING IN MORE THAN ONE CYCLE

For best results, some recipes call for one Cook Power for a certain length of time, and another Cook Power for another length of time. Your oven can be set to change from one to the other and even a third one, automatically.

DO THIS...

THIS HAPPENS...

1. Put food in the oven and close the door.



The COOK CYCLE 1 Signal Light will come on and the Display will show 4 0's.

2. Touch COOK CYCLE 1.



The Display will show the numbers you touched **in the order you touched them**. This example shows 3 minutes, 25 seconds.

3. Touch Number Pads for the cooking time you want in the first cycle.



The COOK POWER Signal Light will come on and the Display will show 2 0's.

4. Touch COOK POWER. (If you want the high Cook Power, skip to step 6.)



The Display will show what you touched. This example shows 60% of full power.

5. Touch a Number Pad for the Cook Power you want in the first cycle.



6. Touch COOK CYCLE 2.



The COOK CYCLE 2 Signal Light will come on and the Display will show 4 0's.



7. Touch Number Pads for the cooking time you want in the second cycle.



The Display will show the numbers you touched **in the order you touched them**. This example shows 4 minutes, 30 seconds.



8. Touch COOK POWER. (If you want the high Cook Power, skip to step 10.)



The COOK POWER Signal Light will come on and the Display will show 2 0's.



9. Touch a Number Pad for the Cook Power you want in the second cycle.



The Display will show what you touched. This example shows 40% of full power.



10. Touch START. For a third cooking cycle, touch COOK CYCLE 3 and repeat steps 7, 8 and 9.



When you touch START, the COOK CYCLE 1 Light will stay on while the oven is cooking in the first cycle. The COOK POWER Light will be on if you are using a Cook Power other than high. All other Signal Lights will go off.



The Display counts down the cooking time to show how much time is left in each cycle.



For 2 of every 10 seconds of countdown, the Display will show the Cook Power you selected, if you are using a Cook Power other than high.



You will hear a beep at the end of each cycle. You can either open the door to check the food, or you can let the oven start the next cycle. If you do open the door, touch START after closing the door to restart the oven.



The COOK CYCLE 2 Light will be on during the second cycle. If a third cycle is used, the COOK CYCLE 3 Light will be on during that.



The COOK POWER Light will be on during any cycle using a Cook Power other than high.



When the last cycle ends you will hear 4 beeps. (You can stop the beeping by opening the door or touching CANCEL.) When the beeping stops, the Display will show the time of day.



COOKING AUTOMATICALLY AFTER DEFROSTING

The controls can be set so the microwave oven goes automatically from defrosting to the Cook Cycles you have touched in

DO THIS...

THIS HAPPENS...

1. Put frozen food in the oven and close the door.



2. Touch DEFROST CYCLE.



The DEFROST CYCLE Signal Light will come on and the Display will show 4 0's.



3. Touch Number Pads for defrosting time you want.



The Display will show the numbers you touched **in the order you touched them**. This example shows 2 minutes, 30 seconds.



4. Touch COOK CYCLE 1.



The COOK CYCLE 1 Signal Light will come on and the Display will show 4 0's.



5. Touch Number Pads for the cooking time you want in the first cycle.



The Display will show the numbers you touched **in the order you touched them**. This example shows 3 minutes, 25 seconds.



6. Touch COOK POWER. (Options: Skip to step 8 if you want the first cycle to cook at high power. Skip to step 12 if you want only one cycle at high power.)



The COOK POWER Signal Light will come on and the Display will show 2 0's.





7. Touch a Number Pad for the Cook Power you want in the first cooking cycle.



The Display will show what you touched. This example shows 60% of full power.



8. Touch COOK CYCLE 2. (Option: Touch START if cooking in only one cycle after defrosting.)



The COOK CYCLE 2 Signal Light will come on and the Display will show 4 0's.



9. Touch Number Pads for the cooking time you want in the second cooking cycle.



The Display will show the numbers you touched **in the order you touched them**. This example shows 4 minutes, 30 seconds.



10. Touch COOK POWER. (Option: Skip to step 12 if you want the second cycle to cook at high power.)



The COOK POWER Signal Light will come on and the Display will show 2 0's.



11. Touch a Number Pad for the Cook Power you want in the second cooking cycle.



The Display will show what you touched. This example shows 40% of full power.



12. Touch START. For a third cooking cycle, touch COOK CYCLE 3 and repeat steps 9, 10 and 11.



When you touch START, the DEFROST CYCLE Signal Light will stay on. All other Signal Lights will go off.



The Display counts down the time to show how much time is left in the defrost cycle.

When the defrost time ends, the microwave oven automatically lets the food stand for the **same amount of time used for defrosting**. The Display counts down the standing time. *During the countdown, the oven will be dark and the fan will be off.* No other Signal Lights will be on.

BEEP

When the standing time is over, you will hear a beep and the first cooking cycle will start



The COOK CYCLE 1 Signal Light will be on during the first cooking cycle. The COOK POWER Light will also be on **if you are using a Cook Power other than high.**

**count
down**

The Display counts down the time to show how much time is left in the first cooking cycle.

60:

For 2 of every 10 seconds, the Display will show the Cook Power you selected if you are using a Cook Power other than high.

BEEP

When the first cooking cycle ends you will hear a beep

**BEEP
BEEP
BEEP
BEEP**

The second cooking cycle will start (If only one cooking cycle is used, you will hear 4 beeps and the oven will stop.)



The COOK CYCLE 2 Signal Light will be on during the second cooking cycle. The COOK POWER Light will also be on **if you are using a Cook Power other than high.**

**count
down**

The Display counts down the time to show how much cooking time is left in the second cycle.

40:

For 2 of every 10 seconds, the Display will show the Cook Power you selected if you are using a Cook Power other than high.

**BEEP
BEEP
BEEP
BEEP**

When the last cooking cycle ends (COOK CYCLE 2 or 3). You will hear 4 beeps. (You can stop the beeping by opening the oven door or touching CANCEL.) When the beeping stops, the Display will show the time of day

Standing time provides more even defrosting and cooking because it allows food temperature to even out.

To skip the automatic standing time:

- Instruct the microwave oven to defrost in DEFROST CYCLE and to cook in COOK CYCLE 2 or 3.

To check or stir foods between or during cycles:

1. Open the door. The oven will shut off.
2. Check, stir or rotate the food.
3. Close the door.
4. Touch START. The oven will go on from where it stopped.

COOKING WITH THE TEMPERATURE PROBE

The MEAL SENSOR Temperature Probe takes guesswork out of cooking roasts and larger casseroles. The probe is designed to turn off the oven when it senses the temperature you want. For suggested temperatures for different foods, see your MICRO MENUS Cookbook.

Final food temperature settings are printed on Number Pads

DO THIS...

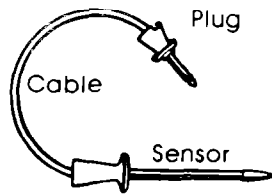

1. Insert at least $\frac{1}{2}$ of the temperature probe into the food

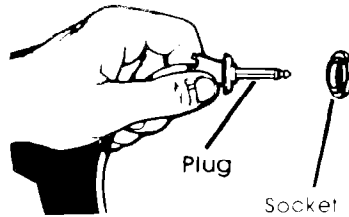

2. Place food in the oven and plug the probe into the socket on the oven wall

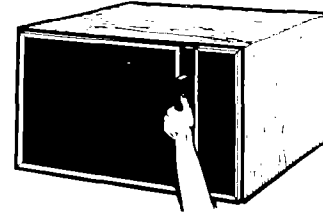

3. Make sure the probe does not touch any part of the oven interior. Close the door.

DO THIS...



4. Touch COOK TEMP.



The COOK TEMP Signal Light will come on and the Display will show 2 0's.



5. Touch a Number Pad for the desired final temperature.



The Display will show the number you touched. This example uses 6, or a final cooked temperature of about 150 F (66 C). The 0 means the food is still cold.



6. Touch COOK POWER. (Option: Touch START if you want to use full power.)



The COOK POWER Signal Light will come on and the Display will show 2 0's.



7. Touch the Number Pad for the Cook Power you want.



The Display will show what you touched. This example shows 60% of full power.



8. Touch START.

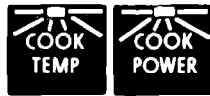

The COOK TEMP and COOK POWER Lights will stay on

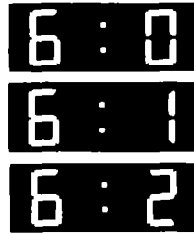

The left number on the display shows what temperature (number) you selected. The right number shows you how the temperature is rising in the food



For 2 of every 10 seconds, the Display will show the Cook Power you selected if you are using a Cook Power other than high



When the probe senses the temperature you selected, the oven shuts off and you will hear 4 beeps. (You can stop the beeping by opening the oven door or touching CANCEL.) When the beeping stops, the Display will show the time of day.

HINTS FOR USING THE TEMPERATURE PROBE

DO...

- use hot pads when removing probe from food or food from oven.
- stir foods during cooking when recommended.
- stir soups, casseroles and drinks before serving.
- cover roasts with foil and let stand a few minutes after cooking. Remove foil if you decide to cook it longer

DON'T...

- let probe or probe cable touch any part of the oven interior.
- let probe touch foil (if used). Foil can be kept away from probe with wooden toothpicks. Remove foil if arcing occurs.
- use paper, plastic wrap or plastic containers. They will be in the oven too long
- use probe in regular oven
- force probe into frozen food.
- use probe for foods that need to simmer.

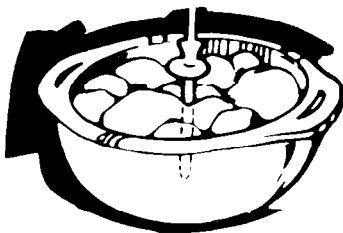

For casseroles, the tip of the probe should be in the center of the food. Stir foods when recommended. Replace the probe.

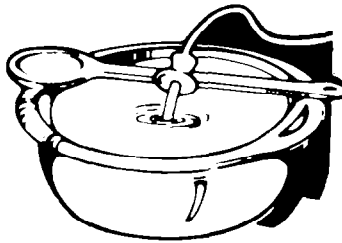

For liquids, balance the probe on a wooden spoon or spatula so the tip of the probe is in the center of the liquid

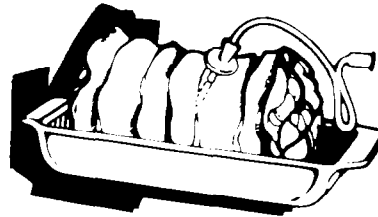

For roasts, the tip of the probe should be in the center of the largest muscle, but not touching fat or bone.

COOKING TO A SERVING TIME

The microwave oven controls can be set to start and stop the oven automatically, even when you are not home. The Serve Time feature allows you to set the time you want the food to be finished cooking.

DO THIS...



1. Touch **SERVE TIME**.



2. Touch Number Pads for the time you want the food to be ready to serve.

3. Touch in the cooking instructions needed for the food to be cooked.



4. Touch **START**.

THIS HAPPENS...



The **SERVE TIME** Signal Light will come on and the Display will show 4 0's. Decide what time you want the food to be done cooking.



The Display will show the numbers you touched **in the order you touched them**. This example shows a Serve Time of 6:00.

Cook in **DEFROST CYCLE**, **COOK CYCLE 1**, **COOK CYCLE 2**, **COOK CYCLE 3** or a combination of them. Use high Cook Power or lower Cook Powers.



If the Display begins flashing, there isn't enough time left before the Serve Time for the oven to do what you told it to do. Touch **CANCEL** and start over with a later Serve Time.



The **SERVE TIME** Signal Light will stay on. All the other lights will go off. When cooking starts, Signal Lights and the Display will show what is happening.

Extra Information:

- Make sure the Clock is set to the right time of day.
- You can't set the Serve Time for more than 12 hours after the correct time of day.
- If you open the door before the oven begins to cook, be sure to retouch **START**.
- If you want the microwave oven to start cooking when you are not home:

Use foods that will not go bad or spoil while waiting for cooking to start. Avoid using dishes with milk or eggs, cream

soups, cooked meats, poultry or fish, or any item with baking powder or yeast.

Smoked or frozen meats may be used; so can vegetables, fruits and casserole-type foods.

Any food that has to wait for cooking to start should be very cold or frozen before it is put in the oven. **MOST UNFROZEN FOODS SHOULD NEVER STAND MORE THAN TWO HOURS BEFORE COOKING STARTS.**

SERVE TIME AND THE TEMPERATURE PROBE

1. Follow instructions on page 14 for plugging in the Temperature Probe.
2. Touch SERVE TIME.
3. Touch the number pads for the time you want the food finished.
4. Follow instructions on pages 14-15 for touching in temperature and cook power instructions.
5. Touch START.

NOTE: When cooking toward a Serve Time while using the Temperature Probe, the microwave oven will start cooking 90 minutes before the Serve Time you set. If you know that cooking time will be less than 90 minutes, set a Serve Time later than you want.

CHANGING OR CANCELLING INSTRUCTIONS

To change or cancel any instructions you have touched, simply touch CANCEL. All instructions will be cancelled. The Display will show the time of day and you can start over.

If you want to change or cancel instructions before you have touched START, simply touch in the new instructions. They will cancel the old ones.

OTHER OPERATING HINTS

These are a number of things you can do with your microwave oven. Some will be reminders. Others will be mentioned for the first time.

1. **To double check settings** while the oven is running, touch the command pad for the setting you want to check. The instruction programmed for that pad will show on the Display for 5 seconds. Then the Display returns to show what the oven is doing.
2. **To stop the oven while it is running:**
 - Open the door. The oven will stop. You can restart it by closing the door and touching START.
 - Touch CANCEL. All instructions will be erased. You must touch in new instructions.
3. If you touch two instructions into the **same** cycle, the second instructions will erase the first.
4. When using a Cook Power other than high, the Display will show the Cook Power for 2 seconds of every 10 during cooking.
5. When COOK CYCLE 1 follows DEFROST CYCLE, a standing time equal to the defrosting time will occur between the two. COOK CYCLE 1 will automatically begin after this standing time.

CLEANING THE MICROWAVE OVEN



Wipe often with warm sudsy water and a soft cloth or sponge.

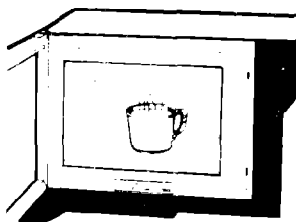

For stubborn soil, boil a cup of water in the oven for 2 or 3 minutes. Steam will soften the soil.

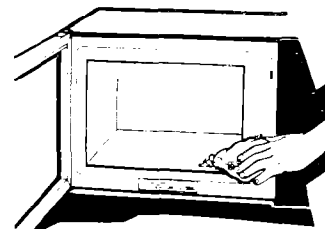

Be sure to clean the areas where the door and oven frame touch when closed. Rinse well.

Abrasive cleaners, steel wool pads, gritty wash cloths and the like **can damage the control panel and electronics**. Use a soft cloth or a sponge with a mild detergent or commercial glass cleaner.

CLEANING THE PROBE:

1. Remove probe from microwave oven using hot pads.
2. Wipe probe with a hot sudsy cloth. Use a plastic scouring pad to remove stubborn foods.
3. Probe may be placed in the silverware basket of the dishwasher.
4. Be careful not to kink the cable.

NOTE: Make sure you have the right probe for your oven. It will have "HI-Z" on the handle.

BI-LEVEL COOKING RACK

Use the Bi-Level Cooking Rack when cooking in more than one container. The rack can be turned upside-down to help fit taller containers on the bottom of the oven. See the MICRO MENUS® Cookbook provided with your oven.

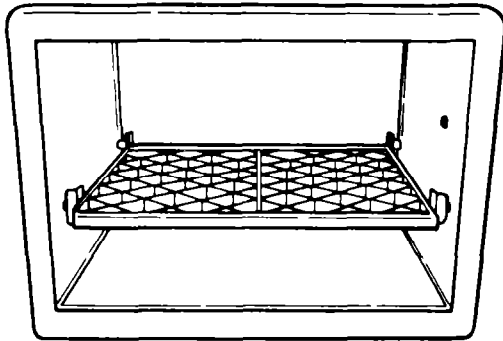

First Position: Use the rack only when heating more than one container of food.
Do not let a container touch the top of the oven.

CLEANING THE RACK

- Wash by hand with a mild detergent or in your dishwasher.
- **Do not** use abrasive scrubbers or cleansers.

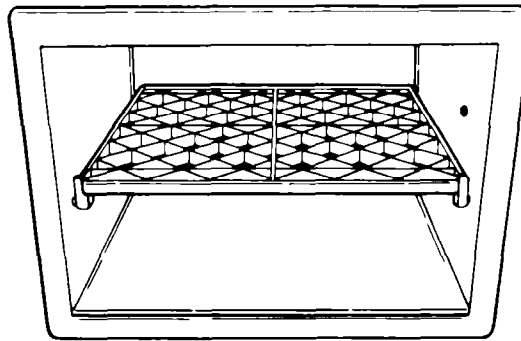

Second Position: Turn rack upside-down when using a taller container on the bottom of the oven.

SPECIAL CAUTIONS

- **Do not use with browning dish.**
- **Use only** when cooking foods in more than one container.
- **Use only** in the microwave oven.
- **Do not** let food or container touch the top of the oven.
- **Do not** store rack in the oven.
- Put food in containers, then place containers on rack.
- **Do not** cook foods directly on rack without putting them in containers first.

REPLACING THE LIGHT BULB

1. Unplug the power cord.
2. Remove holding screw on access panel.
3. Remove the light bulb from its socket.
4. Replace bulb with a 40-watt **appliance** bulb.
5. Replace the access panel and holding screw.
6. Plug in the power cord.

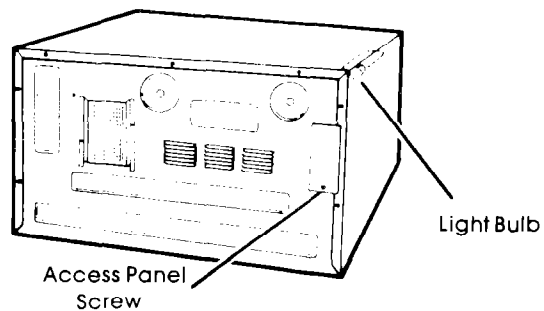

IMPORTANT INFORMATION

Before you start using your microwave oven, read this section carefully. *This information will help you avoid damage to your oven.*

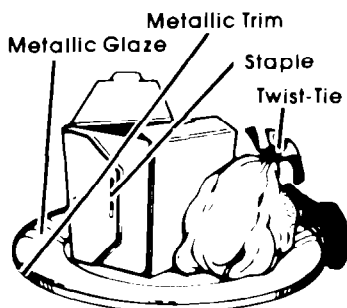

Cooking in metal containers **can damage the oven**. So can containers with **hidden metal** (twist-ties, foil-lining, staples, metallic glaze or trim). *Test dinnerware or cookware before using.*

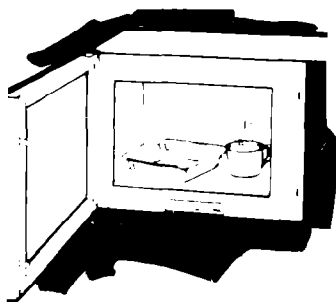

*To test a dish for safe use, put it into the oven with a cup of water **beside** it. Cook on high Cook Power for one minute. **If the dish gets hot and the water stays cool, do not use it.***



NEVER COOK OR REHEAT A WHOLE EGG. Slice hard boiled eggs before heating. Steam build-up in whole eggs may cause them to burst and possibly damage the oven.

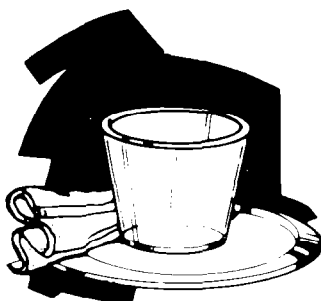

Paper can char or burn, and some plastics can melt if used when heating foods for more than 4 minutes.

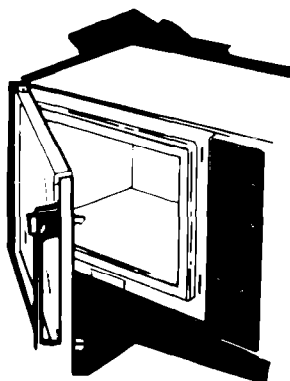

NEVER start a microwave oven when it's empty. The oven can be damaged. If you experiment, put a container of water in the oven.

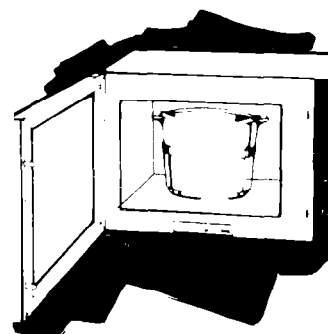

Don't let anything touch the top of the oven cavity.

Continued next page



Rough or harsh cleaners can scratch or dull the oven finish. **DO NOT USE THEM.**

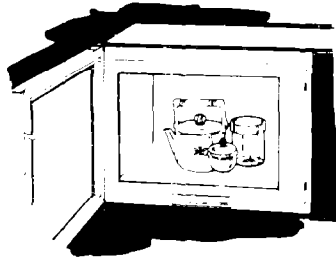

DO NOT store things in the oven.



Overcooking some foods can cause them to scorch or flame...especially foods like potatoes, popcorn, snacks, etc. See the MICRO MENUS® Cookbook.

™Tmk

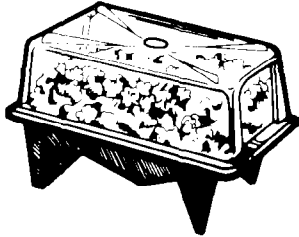

Make popcorn only in poppers designed for use in microwave ovens. Follow popper directions. Results are the popper manufacturer's responsibility.

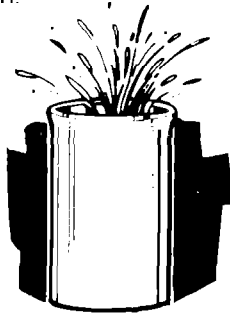

Liquids heated in certain containers may overheat. The liquid may then splash out with a loud noise. This does not harm the oven, but you should not use such containers to heat liquids again.



DO NOT OVERCOOK POTATOES. At the end of the recommended cooking time they should be slightly firm. Wrap in foil and set aside for 5 minutes. They will finish cooking while standing.

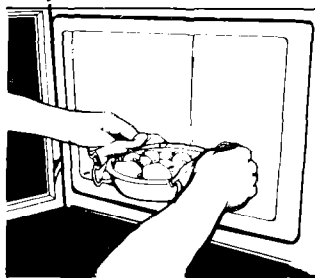

USE HOT PADS. Microwave energy does not heat containers, but the hot food does.



Follow MICRO MENUS® Cookbook directions carefully. If using a different cookbook, you may need to experiment with times and Cook Powers.

- Double-check all settings.
- Use the oven only for defrosting, cooking or reheating.

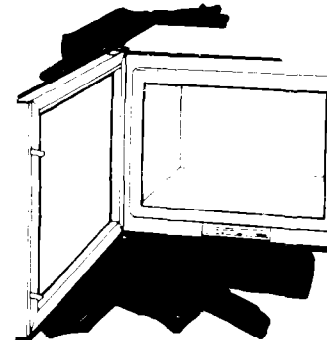

It is normal for the inside of the oven door to look wavy after the oven has been running for a while.

It is normal for the signal lights to flicker while the microwave oven is on.



If your electric power line voltage is less than the normal 120 volts, cooking times may be longer.

HOW MICROWAVE OVENS WORK

Microwave ovens are safe. Microwave energy is not hot. It causes food to make its own heat, and it's this heat that cooks the food.

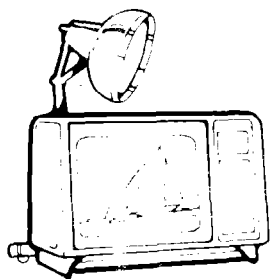

Microwaves are like TV waves or light waves. You can't see them, but you can see what they do.

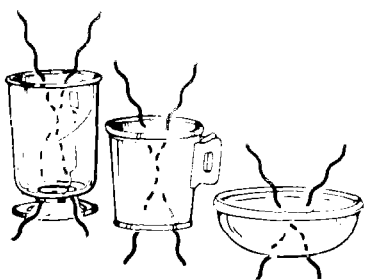

Microwaves pass through glass, paper and plastic without heating them so food absorbs the energy. Microwaves bounce off metal pans so food does not absorb the energy.

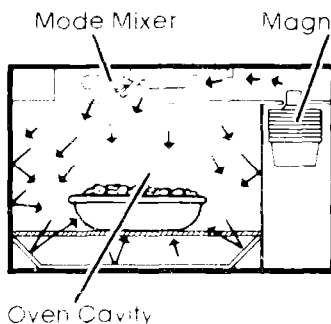

A magnetron in the microwave oven produces microwaves. The microwaves move into the oven where they are scattered or stirred by a mode mixer (like a fan). Microwaves bounce off metal oven walls and are absorbed by food.

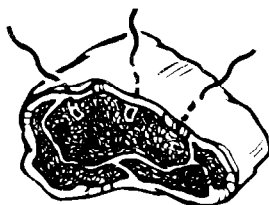

Microwaves may not reach the center of a roast. The heat around the outside is what cooks the roast all the way through. This is one of the reasons for letting some foods (roasts, baked potatoes) stand for a while after cooking, or for stirring some foods during the cooking time.

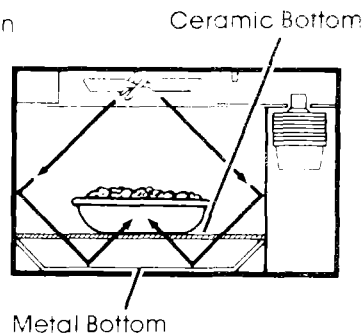

The ceramic bottom of your microwave oven lets microwaves through. Then they bounce off a metal floor, back through the ceramic bottom and are absorbed by the food.



The microwaves disturb water molecules in the food. As the molecules bounce around bumping into each other, heat is made, like rubbing your hands together. This is the heat that cooks.

Building in your microwave oven

Your microwave oven is not limited to carts, counters or tables. Custom installations are made easy with kits available from your dealer.

1. Build the microwave oven into a cabinet or wall by itself or over built-in single ovens in the Whirlpool RDE, REE, RGE, RB and SB model series or Imperial 7200 single gas ovens.
2. Attach the microwave oven to a wall by itself or with cabinets over it.
3. Put the microwave oven on the MICRO SHELF Hood over a cooktop. The hood is available ducted or as a recirculating hood, and includes cooktop lights.

Ask your dealer for details on...

- RCK803 (832849) – 30-inch Built-in Kit
- RCK805 (832856) – 25 1/2-inch Built-in Kit
- RCK807 (832850) – 27-inch Built-in Kit
- RCK710 (832763) – Wall Mount Kit
- RCK811 (832875) – Wall Mount Vent Grille and Filler Kit
- RCK713 (832769) – Wall Mount Cookbook Storage Cabinet
- RH3330XL – MICRO SHELF Hood

If you need service or assistance, we suggest you follow these four steps:

1. Before calling for assistance...

Performance problems often result from little things you can find and fix yourself without tools of any kind.

If nothing operates:

- Is the oven correctly plugged into a live circuit with the proper voltage? (See page 2.)
- Have you checked the main fuse or circuit breaker box?

If the microwave oven will not run:

- Is the timer set?
- Is the Control Panel Switch ON? (See page 6.)
- Is the door firmly closed and latched?
- Did you touch START?
- Did you follow the directions **exactly**?

If the microwave oven has been stored in a cold area:

- Allow it to stand for 20 to 30 minutes at room temperature before operating the controls.

If microwave cooking times seem too long:

- Is the electric supply to your home low or lower than normal? Your electric company can tell you if the line voltage is low.
- Is the Cook Power at the recommended setting?
- Are you allowing for more time when cooking more food at one time?

If the display shows a time counting down but the oven is not cooking...

- Is the Minute Timer Signal Light on?
- Is the oven door closed completely?
- Is the oven in a standing time between DEFROST CYCLE and COOK CYCLE 1? (See page 12.)

If the fan seems to be running slower than usual...

- Has the oven been stored in a cold area? The fan will run slower until the oven warms up to normal room temperature.

If there has been a power interruption, the Display will show 88:88. Reset the clock (page 5).

If the microwave oven turns off too soon or not soon enough when using the probe:

- Is at least $\frac{1}{3}$ of the probe in the food?
- Is the probe tip in the center of the food?
- Is the probe touching bone or fat?
- Have you allowed roasts to stand for a few minutes after cooking?
- Is the probe plugged tightly into its socket?
- Is the Cook Power set where it should be?
- Is the Cook Temperature set at the end temperature you want?
- Do you have the correct probe for your oven? See page 17.

2. If you need assistance* ...

Call the Whirlpool COOL-LINE® service assistance telephone number. Dial free from:

Continental U.S. (800) 253-1301

Michigan (800) 632-2243

Alaska & Hawaii (800) 253-1121

and talk with one of our trained Consultants. The Consultant can instruct you in how to obtain satisfactory operation from your appliance or, if service is necessary, recommend a qualified service company in your area.

3. If you need service* ...



Whirlpool has a nationwide network of franchised TECH-CARE® Service Companies. TECH-CARE service technicians are trained to fulfill the product warranty and provide after-

warranty service, anywhere in the United States. To locate TECH-CARE service in your area, call our COOL-LINE service assistance telephone number (see Step 2) or look in your telephone directory Yellow Pages under:

**APPLIANCES—HOUSEHOLD—
MAJOR—SERVICE & REPAIR**

WHIRLPOOL APPLIANCES—
FRANCHISED TECH-CARE SERVICE
SERVICE COMPANIES
K-1 SERVICE CO. 122 Maple
1-800-469-4699

**ELECTRICAL APPLIANCES—
MAJOR—REPAIRING & PARTS**

OR
WHIRLPOOL APPLIANCES—
FRANCHISED TECH-CARE SERVICE
SERVICE COMPANIES
K-1 SERVICE CO. 122 Maple
1-800-469-4699

OR

**WASHING MACHINES, DRYERS
& IRONERS—SERVICING**

WHIRLPOOL APPLIANCES—
FRANCHISED TECH-CARE SERVICE
SERVICE COMPANIES
K-1 SERVICE CO. 122 Maple
1-800-469-4699



4. If you have a problem* ...

Call our COOL-LINE service assistance telephone number (see Step 2) and talk with one of our Consultants, or if you prefer, write to:

Mr. Guy Turner, Vice President
Whirlpool Corporation
Administrative Center
2000 US-33 North
Benton Harbor, MI 49022

If you must call or write, please provide: model number, serial number, date of purchase, and a complete description of the problem. This information is needed in order to better respond to your request for assistance.



FSP is a registered trademark of Whirlpool Corporation for quality parts. Look for this symbol of quality whenever you need a replacement part for your Whirlpool appliance.

FSP replacement parts will fit right and work right, because they are made to the same exacting specifications used to build every new Whirlpool appliance.



Benton Harbor, Michigan. Automatic Washers, Clothes Dryers, Freezers, Refrigerator-Freezers, Ice Makers, Dishwashers, Built-In Ovens and Surface Units, Ranges, Microwave Ovens, Compactors, Room Air Conditioners, Dehumidifiers, Central Heating and Air Conditioning Systems.